

Ogi Q

technical specification



.mdd

.mdd has a leading position among manufacturers of office furniture with many awards that prove quality and continuously increase demand for it's products.

The realities of today`s market require constant quality improvement at all levels of modern organization. This applies in particular to customer service, marketing, quality of products and also to quality of processes within the company.

Partnership relations among employees and with business partners form a base of economic growth and success of the company.

Constant investments in innovative machinery park, optimization of management systems and an expansion of production halls allow to minimize the lead times for the product of the highest quality.

More than twenty years of experience in office furniture industry come with reference from a long list of companies and institutions to show their appreciation for an efficient and comprehensive service.

.mdd is higly aware of the environment.

Being located in the forest region with lake by itis side, .mdd takes the nature seriously and invests constantly in a modern and energy-efficient solutions to preserve the local life. Company puts emphasis on waste segregation and recycling. .mdd has been awarded for the exceptional care and involvement in waste disposal. All materials used are environmentally friendly and enjoy a high 95 % rate of being recycled.



General informations:

Warranty:

.mdd products – **5 years.**

Electrical components and fabric – **2 years.**

Certyficate - MFC:



Compliant with standards:

PN-EN 527-2:2017-02

Boards density:

12 mm - 690 - 750 kg/m³

18 mm - 650 - 690 kg/m³

28 mm - 610 - 630 kg/m³

36 mm - 610 - 630 kg/m³

Assembly:

product delivered in separate elements

Packing:

cardboard, perforated plastic mesh wrap

Ogi desk worktops

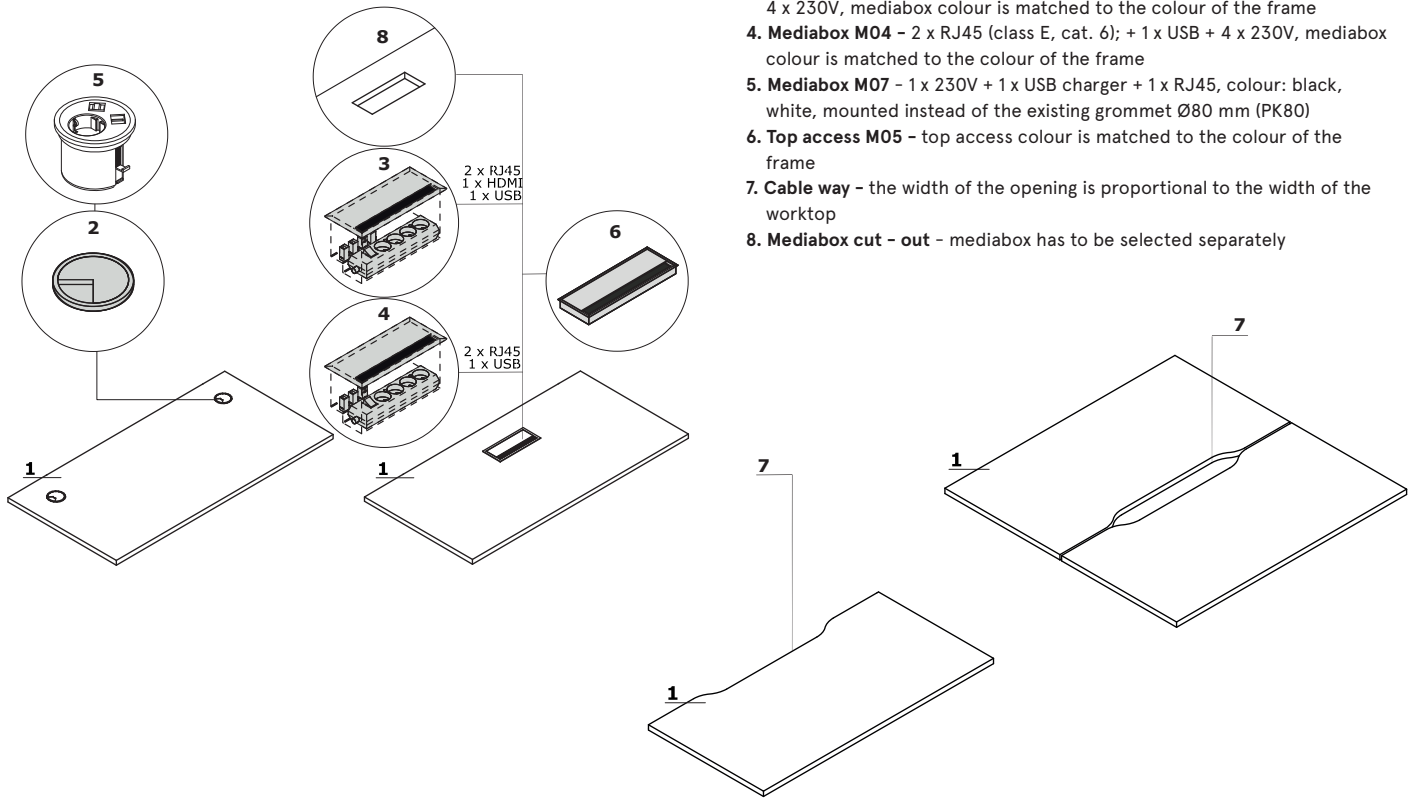

- 1. **Worktop** - MFC 28 mm, ABS edge
- OPTIONS WITH EXTRA CHARGE:**
- 2. **Grommet** - 2 pcs, Ø 80 mm
- 3. **Mediabox M04H** - 2 x RJ45 (class E, cat. 6); + 1 x USB + 1 x HDMI + 4 x 230V, mediabox colour is matched to the colour of the frame
- 4. **Mediabox M04** - 2 x RJ45 (class E, cat. 6); + 1 x USB + 4 x 230V, mediabox colour is matched to the colour of the frame
- 5. **Mediabox M07** - 1 x 230V + 1 x USB charger + 1 x RJ45, colour: black, white, mounted instead of the existing grommet Ø80 mm (PK80)
- 6. **Top access M05** - top access colour is matched to the colour of the frame
- 7. **Cable way** - the width of the opening is proportional to the width of the worktop
- 8. **Mediabox cut - out** - mediabox has to be selected separately

Frame

Ogi Q: powder coated steel, profile 60x20 mm, spacer 10 mm between top and frame

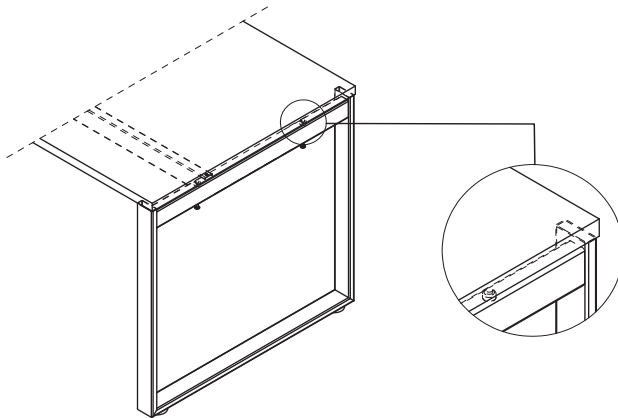

Attention - the cable tray located underneath the worktop is only available in: M009 - aluminium semi-matte colour

Desk with managerial storage

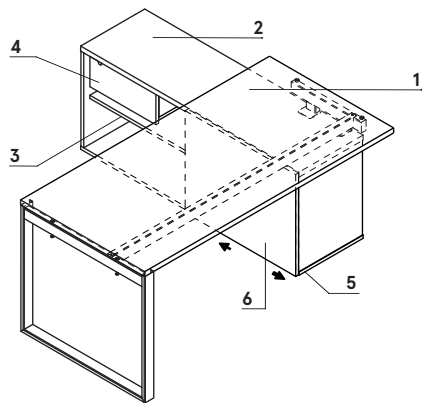

1. **Worktop** - MFC 28 mm, ABS edge
2. **Top** - MFC 28 mm, ABS edge
3. **Shelf** - MFC 18 mm, protection against accidental falling-out, ABS edge
4. **Drawer** - MFC 18 mm, ABS edge, patent lock - possible to change location
5. **Base** - MFC 18 mm, ABS edge
6. **Front** - MFC 18 mm, ABS edge

Configuration examples (mm)

www.mdd.eu

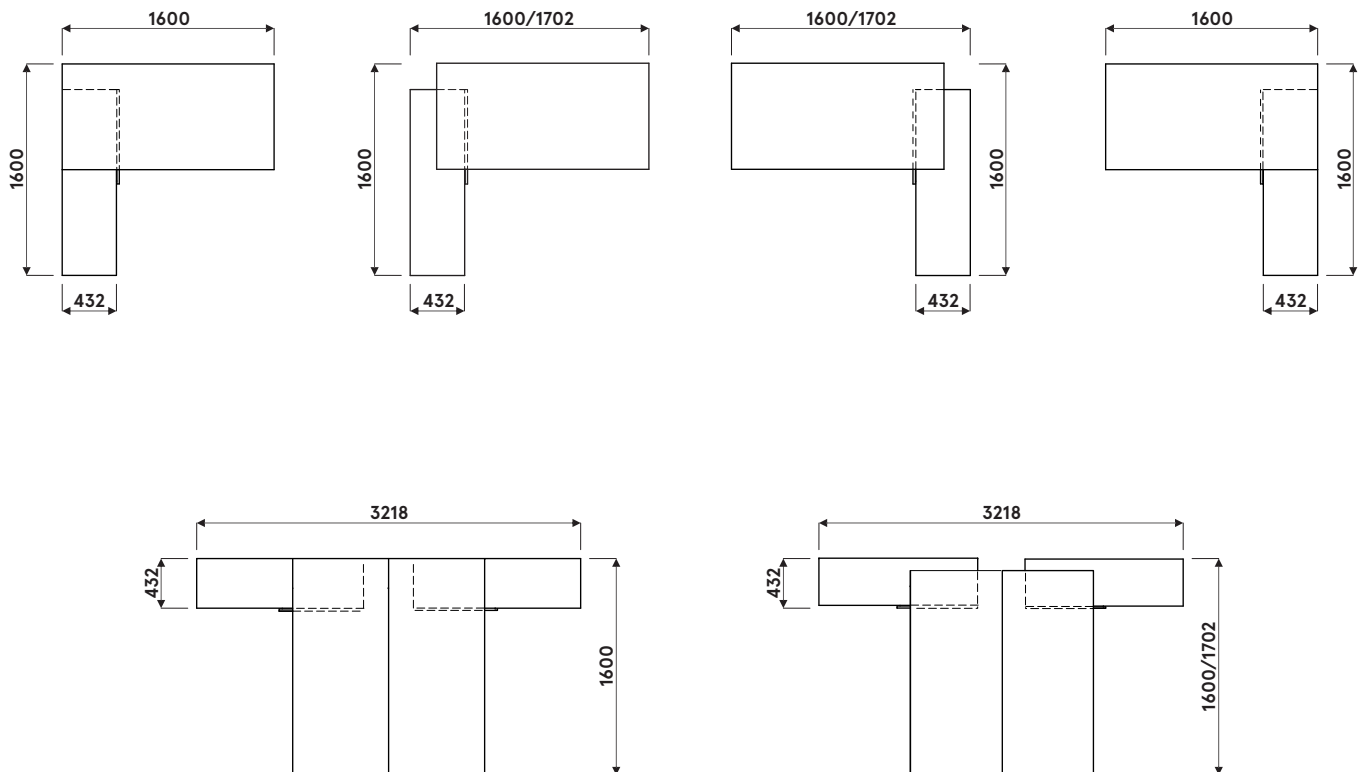

Configuration examples with BOX40, BOX50, BOX60

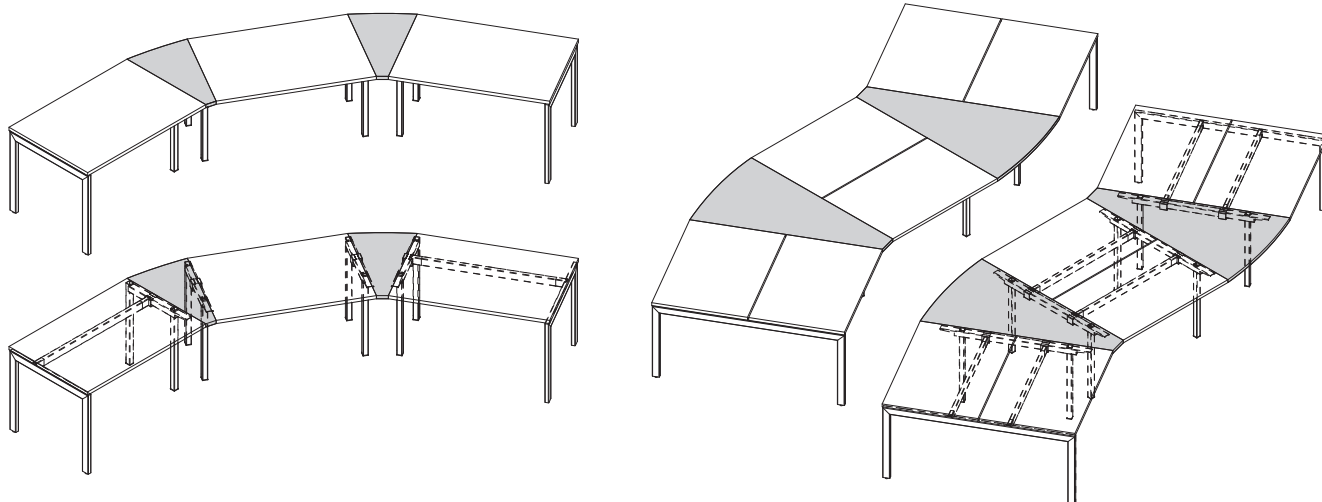

ATTENTION – only for Ogi Q, Ogi U, Ogi Y, Ogi M

Accessories

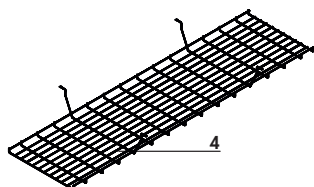
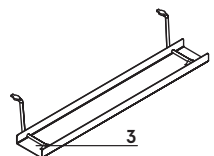
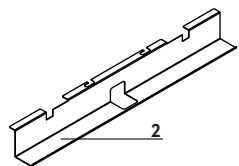
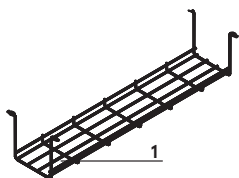

1. Horizontal cable tray S69 – powder coated, colour: 09 – aluminum
2. Single desk horizontal cable tray (SG12, SG16) – powder coated metal, colour: M009 – aluminum semi-matt
3. Horizontal cable tray E64 – powder coated, colour: M009 – aluminium semi-matt
4. Cable tray for bench desks (SG220, SG260) – steel wire Ø4 mm, powder coated, colour: 09 – aluminum

Desks

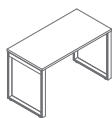

BOQ12
1200 / 600 / 740
31.9 kg

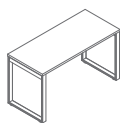

BOQ14
1400 / 600 / 740
35 kg

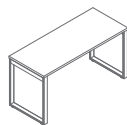

BOQ16
1600 / 600 / 740
38.1 kg

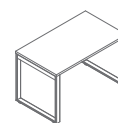

BOQ22
1200 / 700 / 740
35.5 kg

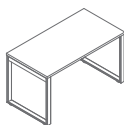

BOQ24
1400 / 700 / 740
38.9 kg

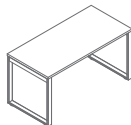

BOQ26
1600 / 700 / 740
42.5 kg

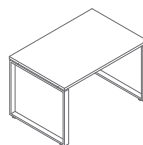

BOQ02
1200 / 800 / 740
41 kg

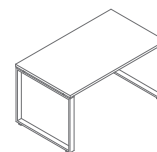

BOQ03
1400 / 800 / 740
41.5 kg

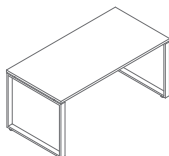

BOQ04
1600 / 800 / 740
42.1 kg

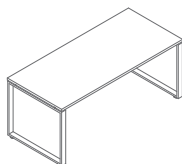

BOQ05
1800 / 800 / 740
45.2 kg

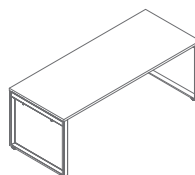

BOQ06
2000 / 800 / 740
51.5 kg

www.mdd.eu

Elements for arrangement building - straight desk



BOX40
500 / 800 / 740
10.8 kg

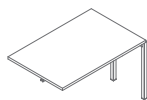

BOX42
1200 / 800 / 740
31.6 kg

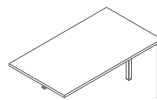

BOX43
1400 / 800 / 740
32.1 kg

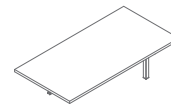

BOX44
1600 / 800 / 740
32.7 kg

Elements for arrangement building - straight desk

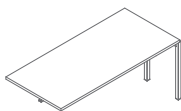

BOX45
1600 / 800 / 740
35.8 kg

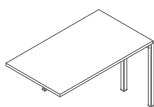

BOX32
1200 / 700 / 740
26.3 kg

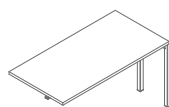

BOX34
1400 / 700 / 740
29.7 kg

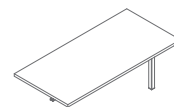

BOX36
1600 / 700 / 740
33.3 kg

Bench desks

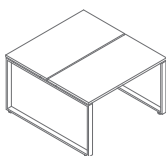

BOQ42
1200 / 1410 / 740
51.9 kg

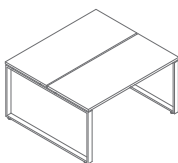

BOQ44
1400 / 1410 / 740
58.7 kg

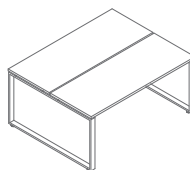

BOQ46
1600 / 1410 / 740
65.9 kg

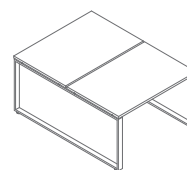

BOQ32
1200 / 1610 / 740
61 kg

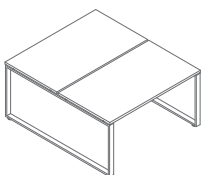

BOQ33
1400 / 1610 / 740
62.6 kg

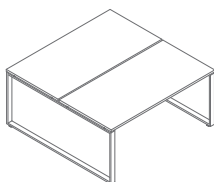

BOQ34
1600 / 1610 / 740
63.8 kg

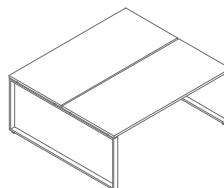

BOQ35
1800 / 1610 / 740
70 kg

www.mdd.eu

Elements for arrangement building - bench

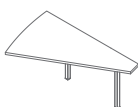

BOX50
1000 / 1410 / 740
16.5 kg

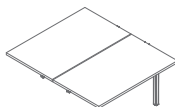

BOX52
1200 / 1410 / 740
49.4 kg

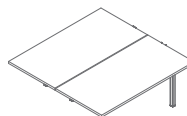

BOX54
1400 / 1410 / 740
56.2 kg

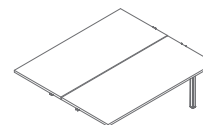

BOX56
1600 / 1410 / 740
63.4 kg

Elements for arrangement building - bench

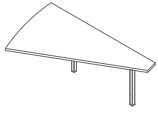

BOX60
1000 / 1610 / 740
17,5 kg

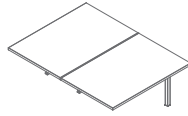

BOX62
1200 / 1610 / 740
60.1 kg

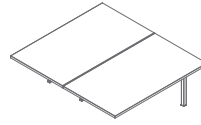

BOX64
1400 / 1610 / 740
61.1 kg

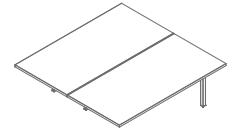

BOX66
1600 / 1610 / 740
62.3 kg

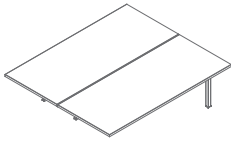

BOX68
1800 / 1610 / 740
68,5 kg

Desks with managerial storage

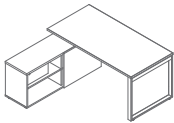

BOQL20
1600-1702 / 1600 / 740
94.4 kg

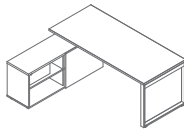

BOQL21
1800-1902 / 1600 / 740
97,5 kg

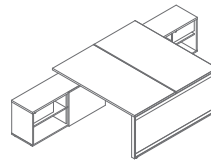

BOQL40
1600-1702 / 3210 / 740
185,8 kg

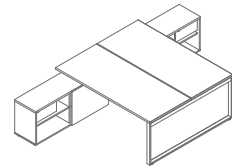

BOQL41
1800-1902 / 3210 / 740
192 kg

Desk extensions

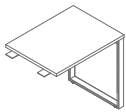

PLQ01
600 / 800 / 740
19,5 kg

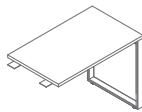

PLQ02
600 / 1000 / 740
20,7 kg

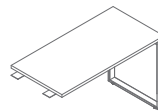

PLQ03
600 / 1200 / 740
23,2 kg

Worktop, top, base, body, front

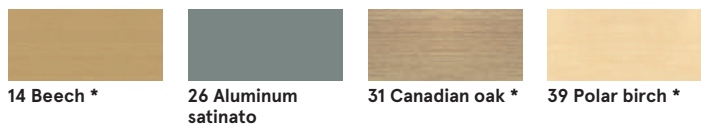

14 Beech * 26 Aluminum satinato 31 Canadian oak * 39 Polar birch *

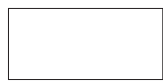

67 White pastel



34 Chestnut * 64 Cocoa * 106 Lowland walnut * 154 Anthracite



08 Black 167 Grey oak 168 Natural oak

Grommet

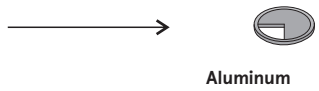

Aluminum

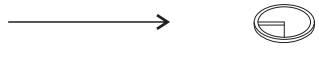

White

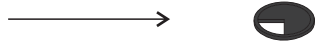

Black

Frame, mediabox - metal



M009 Aluminum semi-matt RAL9006 M015 White semi-matt RAL9010 M154 Antracite semi-matt RAL7043 M115 Black semi-matt RAL9005

* body - II group